



Not intended to be a complete Owner's Manual. Available upon request.

Owner's Manual

DefendAir® HEPA 500

Air Scrubber

115v Model

Quick Reference Table of Contents

How the DefendAir HEPA 500 works
(pg. 2)

**Getting to Know Your New
DefendAir HEPA 500** (pg. 2)

- Location of key features

Operating Instructions (pg. 3)

- Set-up
- The control panel
- Filters

**Applications for the DefendAir HEPA
500** (pg. 4)

- Primary uses
- Specialized features

Maintenance (pg. 5)

Specifications (pg. 6)

DRI-EAZ PRODUCTS, INC.

15180 Josh Wilson Road, Burlington, WA USA 98233

Phone: 800-932-3030 or (360) 757-7776

Fax: (360) 757-7950

www.dri-eaz.com

Owner's Manual

DefendAir® HEPA 500 Air Scrubber

115-volt model

READ AND SAVE THESE INSTRUCTIONS

Use and Operation

WARNING



FIRE AND ELECTRIC SHOCK HAZARD

Unit must be electrically grounded.

- Insert 3-prong plug on power cord directly into matching grounded receptacle.

- Do not use with an adapter

Keep wiring and motor dry.

- Do not operate in standing water
- If electrical components become wet, allow them to dry completely before using.

Read and understand manual before use.

INTRODUCTION

The DefendAir® HEPA 500 is a portable filtration system that draws air in from the surrounding environment and passes it through an advanced filtration system. The unit removes airborne particles like dust, mold spores, pollen, pet dander and miscellaneous debris.

HOW THE DEFENDAIR® HEPA 500 WORKS

The HEPA 500 uses an efficient mix of airflow and filtration to create "cleaner" air. The unit's maximum 500 CFM motor draws air into two types of filters—a pre-filter and a HEPA filter. The first stage of filtration captures larger particles, and the second stage of filtration captures much smaller particles down to 0.3 microns.

What makes the Dri-Eaz DefendAir HEPA 500 unique is its Clean Air Delivery Rate (CADR) capability. CADR is an Association of Home Appliance Manufacturers' (AHAM) rating that tells you how efficiently the machine and filter work together to remove particles from the air at the airflow rate you're using.

You can use the DefendAir HEPA 500 for mold remediation and/or water damage restoration. **The unit is not intended for asbestos remediation.**

GETTING TO KNOW YOUR NEW DEFENDAIR HEPA 500

Location of key features

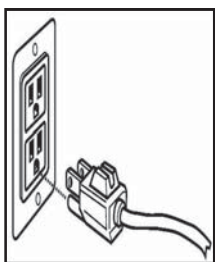

Use a 115V, 3-prong grounded connection

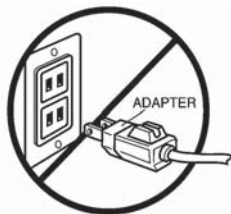

Do not use with an adapter

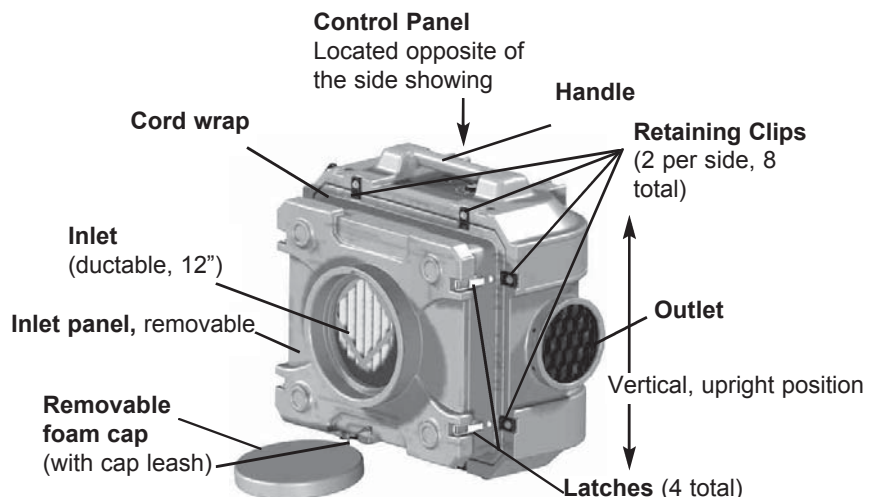

FIGURE 1
HEPA 500

READ AND SAVE THESE INSTRUCTIONS

WARNING

CONTAMINATION HAZARD

Wear NIOSH-approved protective gear when changing filters.

Change filters after every remediation job.

Change HEPA filter when the filter indicator light comes on.

Dispose of used filters according to your local regulations.

Read and understand manual before use.

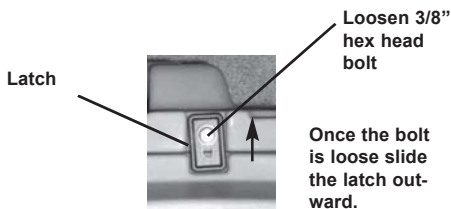

FIGURE 2
Loosening the latches

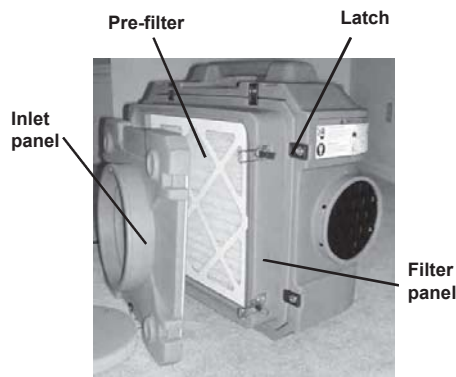

FIGURE 3
Pre-filter

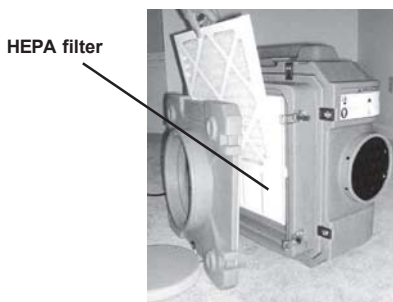

FIGURE 4
HEPA filter

OPERATING INSTRUCTIONS

Setup

1. Unwrap the cord wrap completely
2. Place the HEPA 500 upright (vertical with handle at the top)
3. Plug in to a standard 115 volt outlet. Each HEPA 500 needs 3 amps to operate.
4. To switch the unit on, locate the control panel and turn the variable speed switch clockwise to start the unit (see "Control Panel" below). Then select either a maximum (500 CFM) or down to a minimum (250 CFM) airflow rate. To maintain the optimal CFM, consult the IICRC S520 standards, 10.3.1. See this manual's "Resources" section (pg.5) for how to get an S520 standards guide.
5. The HEPA 500 is multi-positional. For more information, see "Specialized Features" on (pg. 4).

The Control Panel



Variable Speed Control

Note that the MAX setting is located immediately left of the OFF button, and the MIN setting requires an almost 360 degree clockwise turn.

Change Light

The change light illuminates when you need to change the HEPA filter.

The Auxiliary Outlet

You can "daisy chain" or interconnect up to 3 HEPA 500's to customize your air filtration needs. The unit can conduct a maximum of 12 amps when it is turned off, and 9 amps when it is turned on. That means you can plug other equipment into the unit, but the amperage is limited.

Red Circuit Breaker Switch

The primary purpose of the circuit breaker is to protect the machine. It turns the unit off when more than 12 amps run through the on-unit circuit.

Ground Fault Circuit Interrupter (GFCI)

The GFCI helps protect the user should it detect a sudden "ground fault," the GFCI will interrupt the electric current. The GFCI will also trip when a short circuit or an overload occurs.

When the GFCI "trips," unplug the unit, and look for potential hazards—standing water, frayed cords, etc.—anything that would cause a surge of electrical current. Relocate the unit and plug it into a different outlet. Then push the "reset" button, and check to see if it's operating; if so, continue use, if not call a Dri-Eaz Technical Specialist at 800-575-5152.

The Filters

About the filters

The HEPA 500 utilizes a 2-stage filtration system designed with the most advanced HEPA filtration technology available. The first stage utilizes a pre-filter (Figure 3), and the second a HEPA filter (Figure 4). The pre-filter captures larger particles, and the HEPA filter captures 99.97% of smaller particles down to 0.3 microns.

For environments with a high volume of aerosolized particles, you can use 2 prefilters to extend the life of the HEPA filter. See "Maintenance" for how often to replace filters.

Changing filters

1. With a 3/8" wrench, loosen the 8 latches holding the inlet panel in place. See Figure 2.
2. Slide the latches outward, away from the center of the inlet panel.
3. Remove the inlet panel.
4. Remove used filters and replace.

See "Maintenance" for how often to replace filters.

READ AND SAVE THESE INSTRUCTIONS

How to get replacement filters

Call your nearest distributor or Dri-Eaz at 800-932-3030.

APPLICATIONS FOR THE DEFENDAIR HEPA 500

Primary Uses

The primary uses for your DefendAir HEPA 500 are:

- Water damage restoration
- Mold remediation (including creating a negative air environment)

Other uses include fire damage restoration, dust control, odor control and sewage remediation. To learn more about these, contact a Dri-Eaz Technical Specialist at 800-575-5152.

Use for Water Damage

In a standard Category 1 water damage situation, place the DefendAir HEPA 500 in the middle of the affected area. Utilize airmovers to lift particles into the air. The HEPA 500 filters the air in the affected area to reduce particle levels during the restoration process.

Mold Remediation

In most cases, the remediation process requires containment of the affected area. Containment prevents the spread of mold spores and other bioaerosols. Only a professional with specialized training in remediation and containment techniques should use the HEPA 500 (or any negative air machine) for remediation. For more information about proper remediation techniques, consult the *IICRC S520: The Standard and Reference Guide for Professional Mold Remediation*. You can get a copy and learn more through the IICRC at (360) 693-5675. You can also contact the Dri-Eaz Education Department for technical advice or to learn more about educational opportunities at 800-575-5152.

Formally trained remediation professionals

Run the HEPA 500 as a negative air machine without interruption for the duration of every remediation job. The HEPA 500 filters 99.97% of particles 0.3 microns and larger, such as mold spores and fungi.



WARNING

TIPPING HAZARD

When stacking units, beware of tipping.

Do not stack more than 2 units on top of each other.

Falling equipment could cause bodily harm.



Read and understand manual before use.



WARNING

BREATHING HAZARD

When using the HEPA 500 in a containment area, turn off all sources of power to open combustion appliances such as fireplaces, boilers, furnaces, water heaters and HVAC systems to avoid the risk of backdrafting deadly carbon monoxide fumes.

If the Filter Change Light illuminates during the remediation process, immediately change the HEPA filter. See "Changing Filters" and "Maintenance" for more information.

To create a negative air environment

You can install the DefendAir HEPA 500 outside a containment area to draw air out of an affected area. (see "Specialized Features," Removable intake panel for remediation professionals).



FIGURE 5

Units daisy chained

Specialized Features

Daisy-chain capability

Dri-Eaz designed the HEPA 500 for optimal versatility. You can interconnect up to three units to create a maximum of 500, 1000, or 1500 CFM using the auxiliary outlet on the unit's control panel. You can also daisy chain the units in a stacked position (see "multi-positional" in this section).

Removable intake panel for remediation professionals

The DefendAir HEPA 500 has a specialized feature to assist containment (Figure 6). There's a removable panel on the intake side of the unit. Lift the 8 latches to release the panel as shown in figure 3. Install the HEPA 500 outside the containment area to draw air out. Cut a hole in the containment plastic the size of the unit's inlet, insert the inlet into the plastic, and seal the circumference tightly with duct tape (no air

READ AND SAVE THESE INSTRUCTIONS

should be able to pass through). A tightly sealed containment area will aid in creating an effective negative pressure. Use a manometer to monitor air pressure. Manometers are available at most equipment supply houses.

Multi-Positional

You can stack and operate up to two HEPA 500s vertically. The handle of one unit fits into bottom of another unit (see Figure 7). You can also stack them horizontally for space-saving storage, or operate a unit with its outlet facing upward.

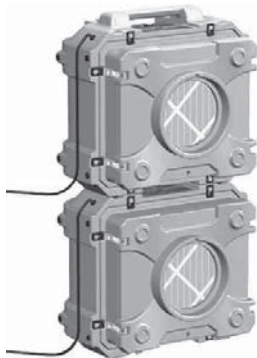

FIGURE 7
Stacking 2 units

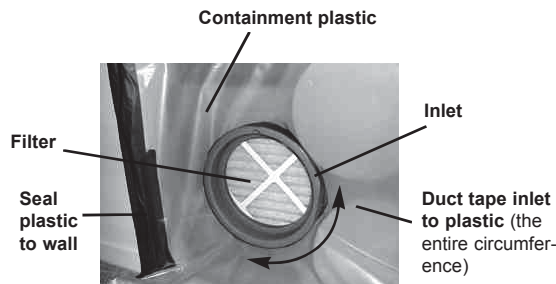

FIGURE 6
Containment (view from inside containment area)

Resources

- Dri-Eaz Guide to Airscrubbing, call Dri-Eaz at 800-932-3030.
- *S520: The Standard and Reference Guide for Professional Mold Remediation*, call the IICRC at 360-693-5675.
- Institute of Inspection, Cleaning and Restoration Certification (IICRC), 360-693-5675.
- Dri-Eaz website and Virtual Training Center (VTC) at www.dri-eaz.com
- Dri-Eaz Education Department, 800-575-5152.
- NIOSH help line 800-35-NIOSH, for respirator and respirator filter information.

⚠️ WARNING



Electric Shock Hazard

Unplug unit before performing any maintenance.

Never use a water hose or pressure washer to clean electrical components; water could enter the electrical compartment causing a shock hazard.

Follow cleaning instructions in manual.

Maintenance

MAINTENANCE INTERVALS



ELECTRIC SHOCK HAZARD

Unplug the DefendAir HEPA 500 before performing maintenance.

Before Each Use



CONTAMINATION HAZARD

Always wear an appropriate NIOSH-approved respirator and personal protective equipment when removing or replacing filters, or when cleaning the DefendAir HEPA 500.

- Inspect the electrical cord for damage. Look for fraying, cuts, etc. Do not use the unit if you find any. Call Dri-Eaz for the nearest Service Center.
- Check your GFCI protection. Plug the unit in and turn it on, depress the red GFCI "Test" button. If it's operating properly the "Reset" button should pop up. (Note: you'll need to depress the "reset" button again for operation.)

When using the DefendAir HEPA 500 for water damage restoration:

- Inspect pre-filter before each use. Look for accumulated dust and dirt that could restrict airflow through the filter into the unit. If any is visible, change out the pre-filter.
- Replace the HEPA filter when the Change Indicator Light comes on.

READ AND SAVE THESE INSTRUCTIONS

Note: To be assured of true HEPA filtration, change the HEPA filter after every water damage job, or when the indicator light comes on; whichever occurs first.

When using the DefendAir HEPA 500 for remediation:

After every job

- Replace both the filters to prevent cross-contamination.
- Clean the unit thoroughly (vacuum and damp wipe per IICRC S520, 10.11) after each job before removing it from the containment area to avoid cross-contamination. Pay particular attention to the area around the air intake. Let the unit dry before installing clean filters.

TROUBLESHOOTING

For any problems not listed below, call your local distributor or contact our Service Department toll free at 888-867-3235.

PROBLEM	CAUSE	SOLUTION
Unit does not operate	<ul style="list-style-type: none"> • No power to machine • Switch not turned on • No power to outlet • GFCI Tripped 	<ul style="list-style-type: none"> • Plug in the unit; check power at outlet • Turn on the switch • Reset circuit breaker/GFCI • Reset circuit breaker/GFCI
Change light illuminated	<ul style="list-style-type: none"> • Primary filter is full • Air intake restricted 	<ul style="list-style-type: none"> • Replace the filters; refer to Maintenance section • Eliminate bends/kinks in ducting, or remove ducting
Blower wheel not turning	<ul style="list-style-type: none"> • Obstructed blower • Loosen blower wheel set screw 	<ul style="list-style-type: none"> • Remove obstruction • Tighten set screw

SPECIFICATIONS

MODEL	F284	CONTROLS	TOUCHPAD
TYPE	115 V	FILTERS	PRE-FILTER (P/N 13-00199) PRIMARY HEPA P/N (F321)
VARIABLE CFM	250-500 CFM	HANDLE	ROTOMOLDED
HEIGHT	24.6" (62.5 CM)	HOUSING	ROTOMOLDED
WIDTH	26.2" (66.5 CM)	POWER 115V	3 AMPS
DEPTH	18.2" (46.2 CM)	CORD LENGTH	25 FT (7.6 M)
USE WEIGHT	44 (19.9 KG)	SAFETY	UL LISTED
SHIP WEIGHT	46 (20.9 KG)	FREQUENCY (HERTZ)	60